

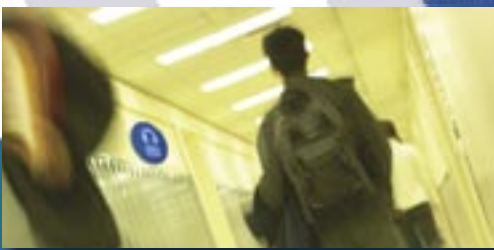

PulsarSafeEar

Noise Warning System



PulsarSafeEar
Safe and Sound

See it before you hear it

Suitable for both noisy and quiet environments:

The PulsarSafeEar is perfect for use in factories, workshops, pubs and nightclubs to warn when noise levels become too high and indicate when hearing protection must be worn.

In environments where the wearing of hearing protection (PPE) may not be required at all times, the PulsarSafeEar will inform employees when PPE is required and also when it can be removed safely.

PulsarSafeEar can also be used in quiet locations such as schools, hospitals and libraries to indicate when noise levels must be kept down. By setting the PulsarSafeEar to trigger at a lower level ensures that noise levels in quiet environments stay within acceptable levels.

Installation & Use

Installation of the PulsarSafeEar is very simple. Select the trigger level and connect the power supply to the unit. When the noise level measured by the microphone reaches this level, the sign will illuminate and show the warning.

The unit can also be set to keep the warning illuminated for up to 30 seconds after the level has fallen back below the trigger level. This removes the sudden on-off indication that traditional noise warning signs often produce. The PulsarSafeEar eliminates confusion as to when hearing protection (PPE) should be worn.

The sound level chosen for the trigger point can be set using the simple level selection at the back of the unit.

Remote Display Units

The PulsarSafeEar is also available as a Remote Display Unit which is controlled by a Master PulsarSafeEar Unit. A simple cable from the Master to up to 3 remote units can be daisy-chained together so that an area of up to 30 metres can be covered.

Record & Store with PulsarSafeEar Data Logging Software

The PulsarSafeEar can be upgraded to become a data logging unit by adding the PulsarSafeEar Data Logger and USB Software. The Data Logger simply plugs into the PulsarSafeEar and can record noise levels over long periods of time. The Data Logger can be programmed to start recording at a specific time and date and run, for example, over an 8 hour shift.

When the Data Logger is plugged into a PC the software will display a graph of the recorded noise levels and allow the data to be printed, exported and annotated for reference.

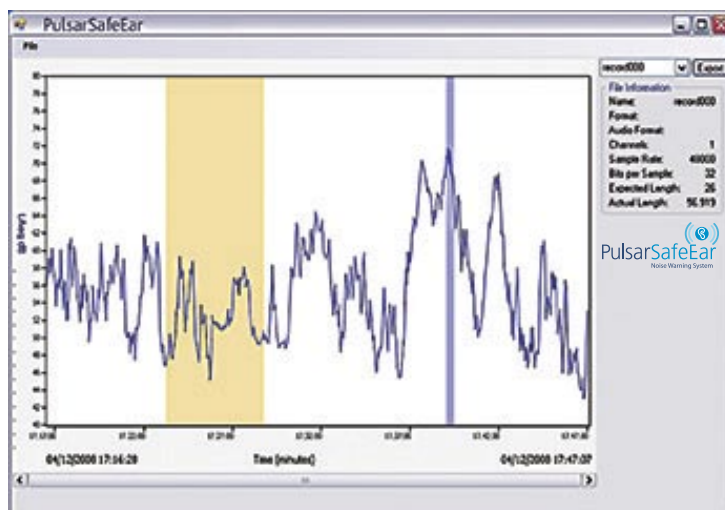

Setting up your PulsarSafeEar system

Master guide set up instructions

1. Check contents

PulsarSafeEar



x1

Power Supply with UK, US & EU plugs



5m Power Extension Cable



x1

Microphone



x1

Wall mounting screws & wallplugs

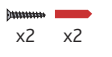

x2 x2

2. Trigger Level & delay

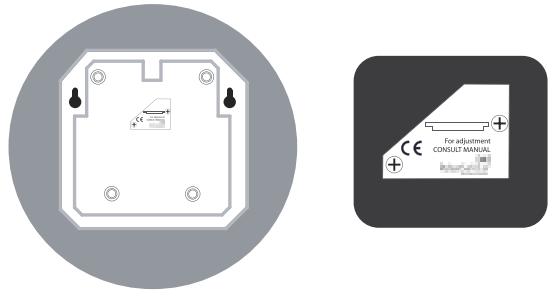

When setting the trigger level, remember that this is the level at the microphone. Adjust the level to take account of any distance between the microphone and noise source.

3. Set Trigger Level

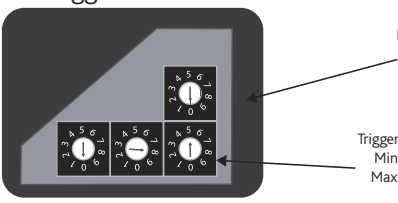

Brightness Level 0-9

Trigger Level Settings Minimum: 40dB Maximum: 120dB

Add '800' to the dB level to disable the 30 second turn-off delay.

Examples:

Trigger Level = 0	8	5 = 85dB(A) 30 second turn-off delay
Trigger Level = 8	8	5 = 85dB(A) no turn-off delay
Trigger Level = 0	4	5 = 45dB(A) 30 second delay
Trigger Level = 8	4	5 = 45dB(A) no turn-off delay
Trigger Level = 1	0	0 = 100dB(A) 30 second turn-off delay
Trigger Level = 9	0	0 = 100dB(A) no turn-off delay

4. Connect Microphone & Power

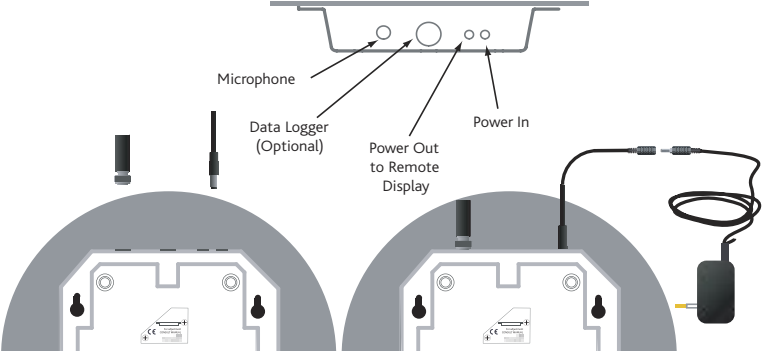

Microphone

Data Logger (Optional)

Power In

Power Out to Remote Display

5. Wall mounting. Use the template provided below to position the unit on the wall

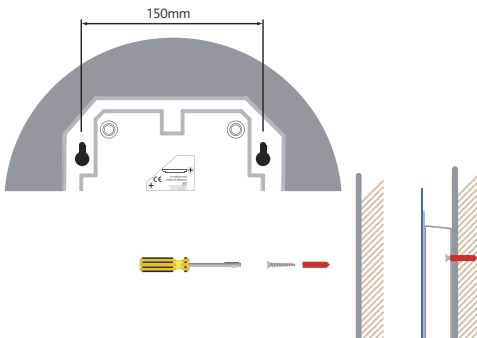

150mm

6. Connect Microphone & Power

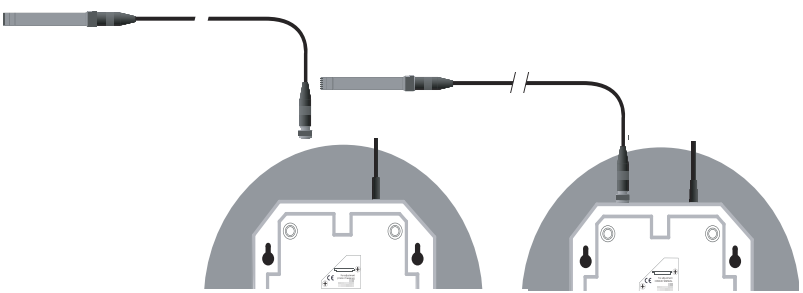

An extension cable can be used with the PulsarSafeEar to allow the microphone to be positioned remotely. This requires an optional preamplifier, microphone capsule and extension cable.

7. USB Data Logger



a

Install the PulsarSafeEar Software

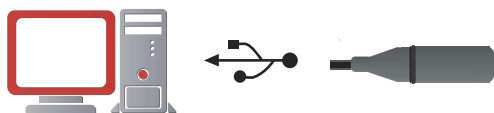

b

Connect the PulsarSafeEar DL Data Logger to the PC and run the PulsarSafeEar Software. Configure & start the Data Logger.

Setting up your PulsarSafeEar system

Master Unit set up instructions

8. USB Data Logger

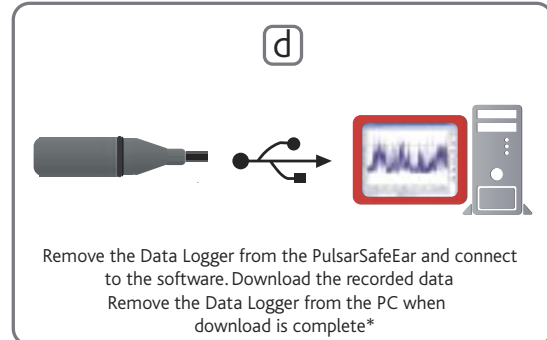
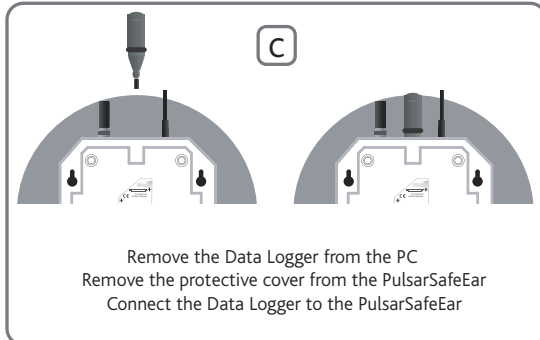

*The Data Logger should be removed from the PC when not in use to prevent the battery from being discharged.

Take care when connecting the Data Logger to a USB port on the PC. Ensure that the Data Logger does not fall out of the socket or become loose in the socket. For troubleshooting & help, please visit the PulsarSafeEar Website at www.pulsarinstruments.com/safeear

Remote Display Unit set up instructions

1. Check contents

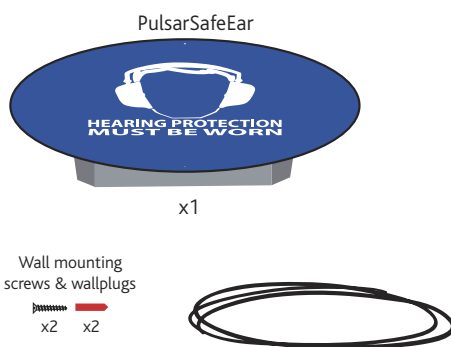

2. Connect cable between Remote and Master Unit

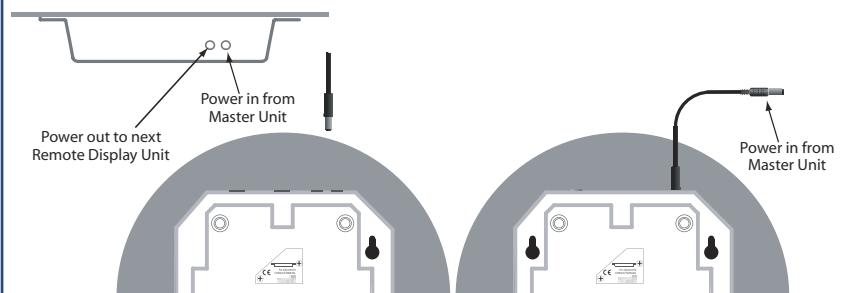

3. Option: connect additional Remote Units

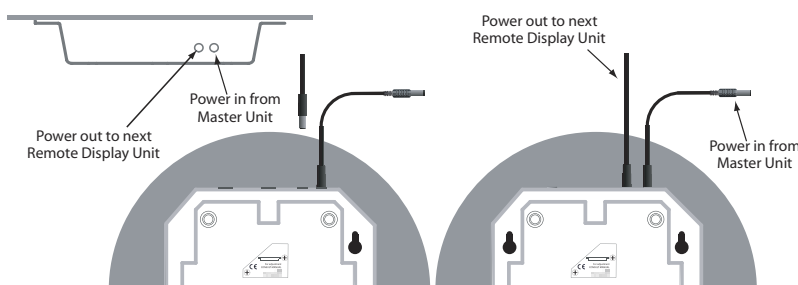

4. Wall mounting. Use the template provided below to position the unit on the wall

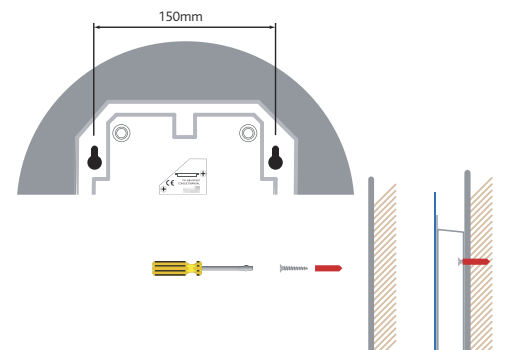

Contact us for more information

Call: 01723 518011

email us at: sales@pulsarinstruments.com

Please visit our website: www.pulsarinstruments.com

Follow the conversation @PulsarMeters

or join us at: www.linkedin.com/company/pulsar-instruments-plc



Key features

- Lights up when a pre-set noise level is exceeded
- Quick and simple to install
- Trigger level from 40dB(A) to 114dB(A)
- Suitable for both quiet and noisy environments
- Adjustable, high intensity white LED technology for high visual impact and a long operating life
- 4 standard designs to cover all applications

PulsarSafeEar is also available with a range of other graphics and text which allows it to be used in environments where there is a need to warn or indicate excessive sound levels.

Custom design options are available. Please contact Pulsar Instruments plc for details.

Call: 01723 518011
email us at: sales@pulsarinstruments.com
or visit our website: www.pulsarinstruments.com/safeear



Specifications

Ordering Information

The Master Unit and Remote Display Unit are available with a selection of standard designs which are listed below.

Custom design options are available. Please contact Pulsar Instruments plc for details of these custom design options.

PulsarSafeEar Master Unit with microphone & mains power supply
SafeEarM/A with "Hearing Protection Must Be Worn"
SafeEarM/B with "Warning High Noise Levels"
SafeEarM/C with "Caution! High Sound Levels"
SafeEarM/D with "SHH! Quiet Zone"

PulsarSafeEar Remote Display Unit with 10m inter-connection cable to PulsarSafeEar Master Unit

SafeEarR/A with "Hearing Protection Must Be Worn"
SafeEarR/B with "Warning High Noise Levels"
SafeEarR/C with "Caution! High Sound Levels"
SafeEarR/D with "SHH! Quiet Zone"

Specifications

- Application Noise activated warning sign
- Trigger Level 40dB(A) to 114dB(A)
- Suitable for both quiet & noisy environments
- Microphone PU112
- Frequency Weighting 'A' Weighting to IEC 61672-1:2002
- Time Weighting Slow to IEC 61672-1:2002
- Visual Indication High intensity white LED with four standard designs
- User selectable brightness levels
- Display delay time None or 30 seconds
- External Power 2.1mm Power Jack, 12v DC via PUL200 Mains Power Supply
- Output Control for Remote Display Units via standard 2.1mm Power Connector
- Up to three Remote Display Units can be powered from a Master Unit
- Dimensions 12"mm diameter, 2"mm depth
- Weight 1.3lbs (0.6kg)
- Mounting 2 x Keyhole mounting slots
- Data Logging USB Data Logger with 32,000 Samples of LAS
- (Slow 'A' Weighted Sound Level)
- User Selectable 1 second (9 hours), 10 seconds (3.7 days), 1 minute (22 days) sampling

Supplied Accessories

PulsarSafeEar Master Unit PU200 Mains Power Supply & PU206 5m Power Extension Cable
PulsarSafeEar Remote Display Unit PU207 10m Inter-connection cable to Master Unit
PulsarSafeEar DL Data Logger USB Data Logger & Software CD

Optional Accessories

PUL207 10m Inter-Connection Cable for PulsarSafeEar Units
PUL202 2m Microphone Extension Cable for PulsarSafeEar Master Unit for use with PUL200C & PM222
PUL205 5m Microphone Extension Cable for PulsarSafeEar Master Unit for use with PUL200C & PM222
PUL210 10m Microphone Extension Cable for PulsarSafeEar Master Unit for use with PUL200C & PM222
PUL200C Mains Power Supply
PUL200C Preamplifier
PM222 Microphone Capsule



Version 1



Version 2



Version 3



Version 4

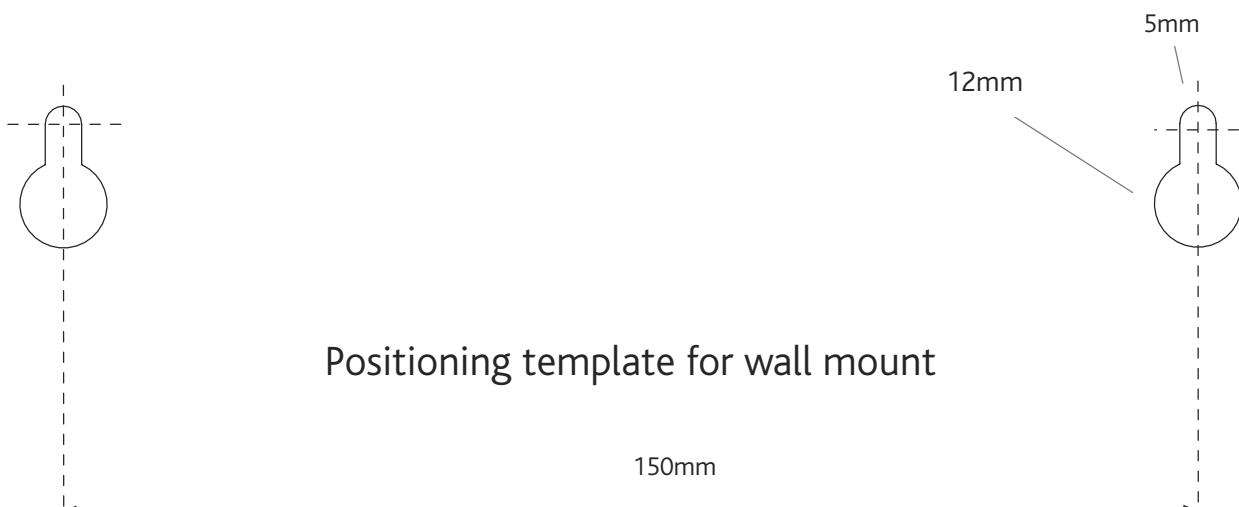

Contact us for more information

Call: 01723 518011

email us at: sales@pulsarinstruments.com

Please visit our website: www.pulsarinstruments.com

Follow the conversation @PulsarMeters

or join us at: www.linkedin.com/company/pulsar-instruments-plc

